



ÇATI IŞIKLIK SİSTEMİ

0800 - YKYKS

ALUFOUR
ÇATI IŞIKLIK SİSTEMİ



ALUFOUR

ÇATI IŞIKLIK SİSTEMİ

PROFİL KODU	AĞIRLIK (kg/m)
SKY-011	1.406

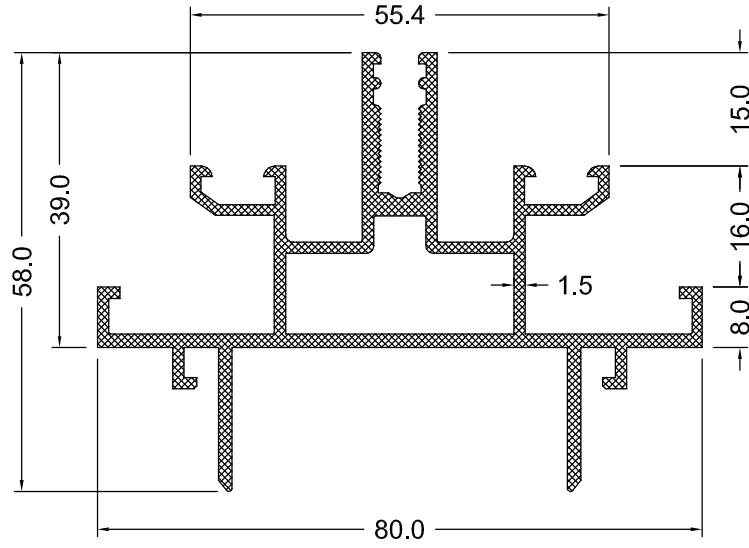

PROFİL KODU	AĞIRLIK (kg/m)
SKY-012	1.504

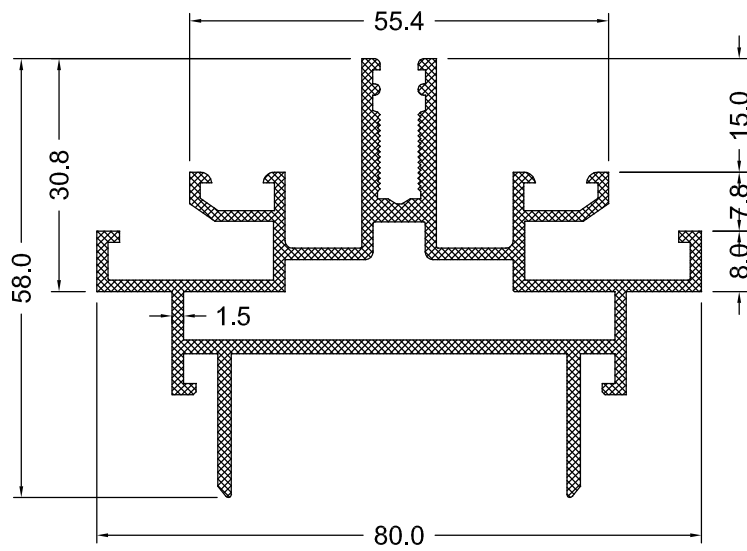

PROFİL KODU	AĞIRLIK (kg/m)
SKY-013	1.466

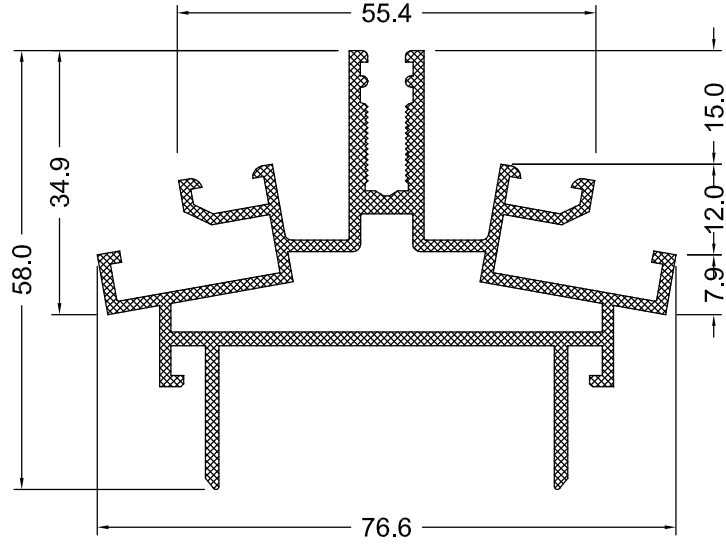

PROFİL KODU	AĞIRLIK (kg/m)
SKY-014	1.176

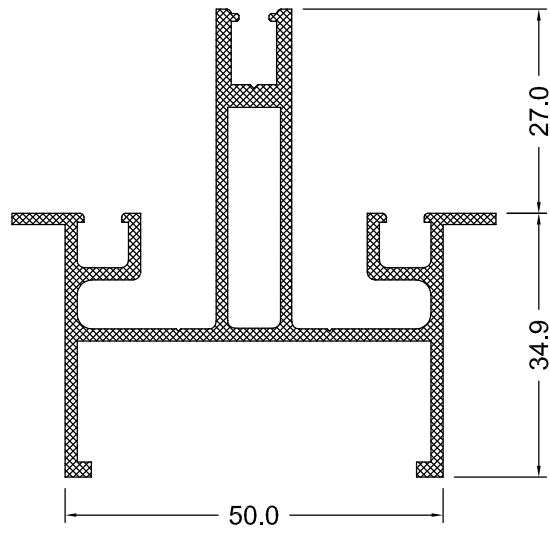

PROFİL KODU	AĞIRLIK (kg/m)
SKY-015	0.881

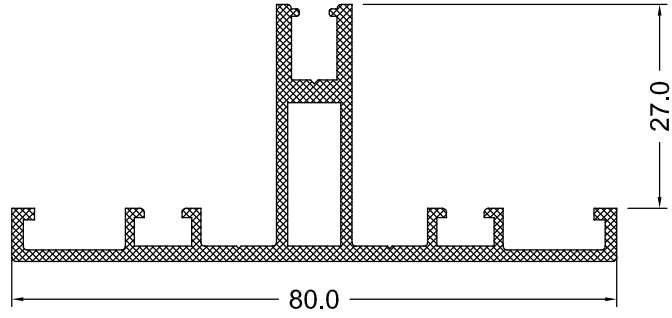

PROFİL KODU	AĞIRLIK (kg/m)
SKY-016	0.685

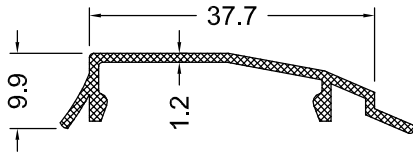
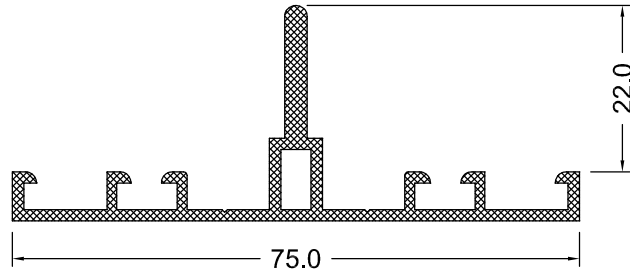

PROFİL KODU	AĞIRLIK (kg/m)
SKY-041	0.230

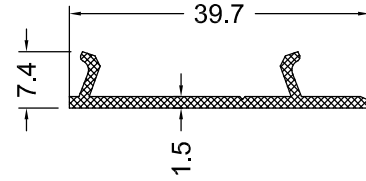

PROFİL KODU	AĞIRLIK (kg/m)
SKY-042	0.206

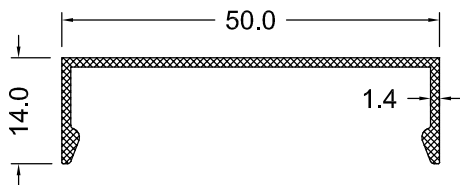

PROFİL KODU	AĞIRLIK (kg/m)
SKY-043	0.263

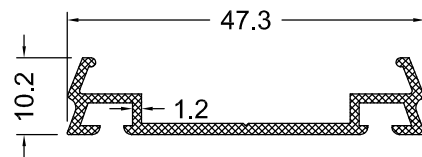

PROFİL KODU	AĞIRLIK (kg/m)
SKY-044	0.292

PROFİL KODU	AĞIRLIK (kg/m)
SKY-073	0.390

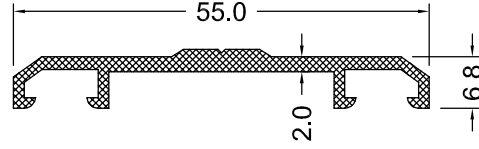

PROFİL KODU	AĞIRLIK (kg/m)
SKY-075	0.469

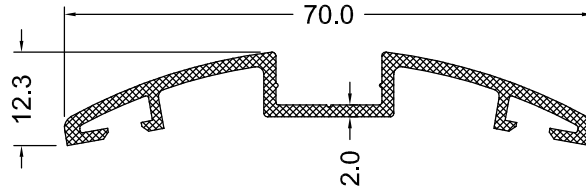

PROFİL KODU	AĞIRLIK (kg/m)
SKY-074	0.049

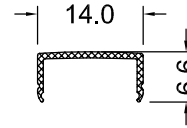

PROFİL KODU	AĞIRLIK (kg/m)
SKY-071	0.322

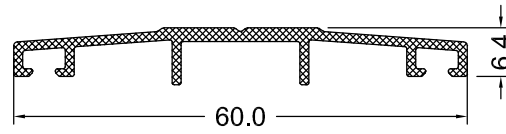

PROFİL KODU	AĞIRLIK (kg/m)
SKY-072	0.322

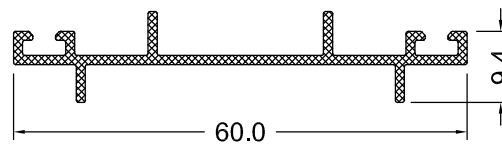

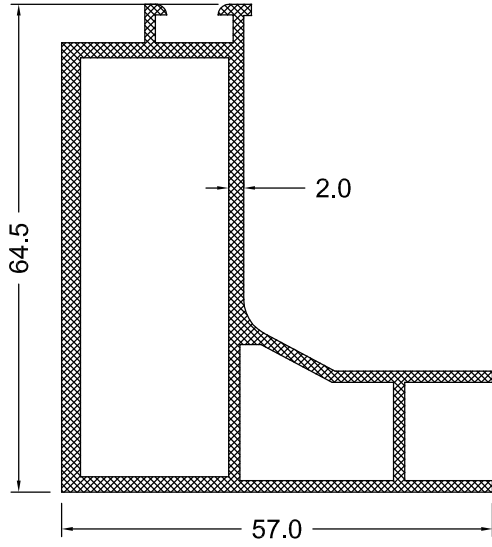

PROFİL KODU	AĞIRLIK (kg/m)
SKY-021	1.301

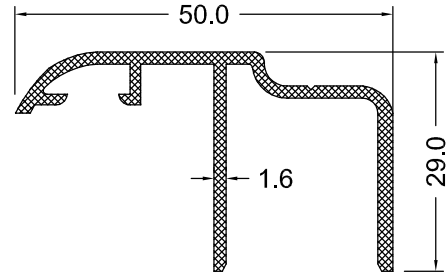

PROFİL KODU	AĞIRLIK (kg/m)
SKY-023	0.509

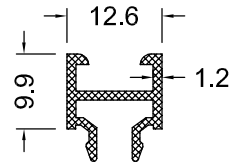

PROFİL KODU	AĞIRLIK (kg/m)
SKY-024	0.146

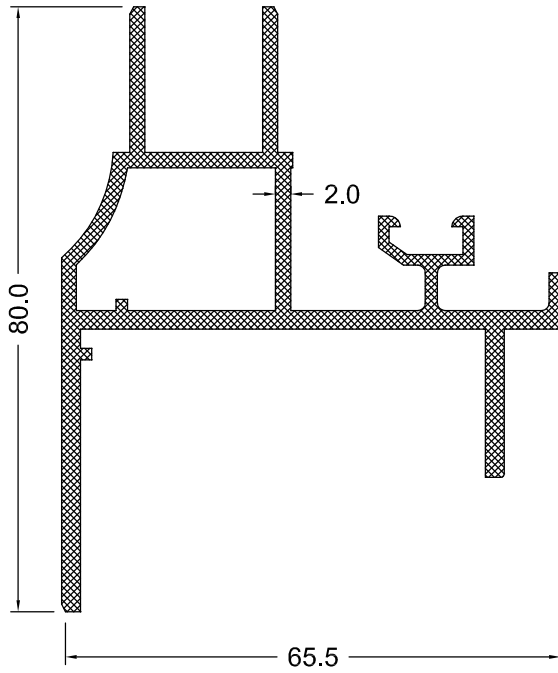

PROFİL KODU	AĞIRLIK (kg/m)
SKY-022	1.528



PROFİL KODU	AĞIRLIK (kg/m)
SKY-081	0.152

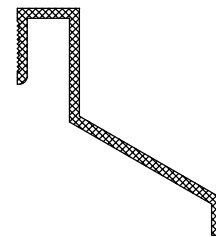

PROFİL KODU	AĞIRLIK (kg/m)
SKY-082	0.195

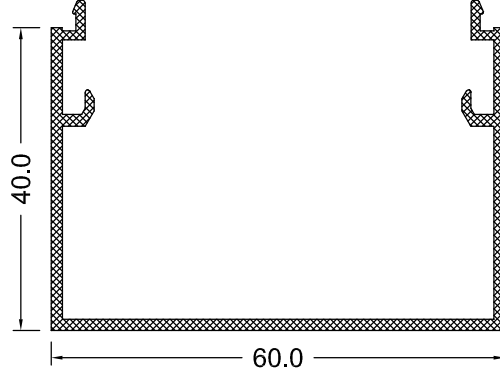

PROFİL KODU	AĞIRLIK (kg/m)
SKY-045	0.650

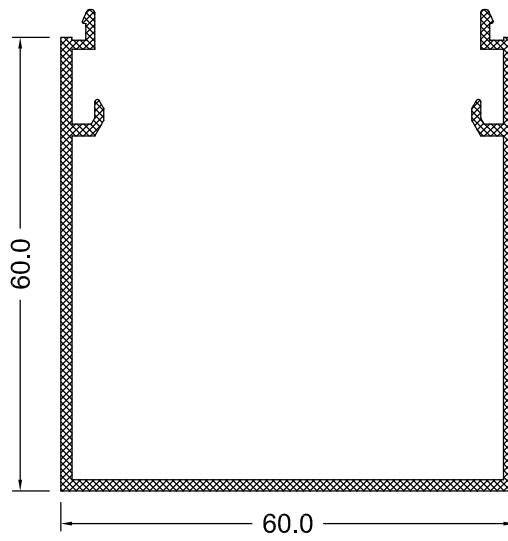





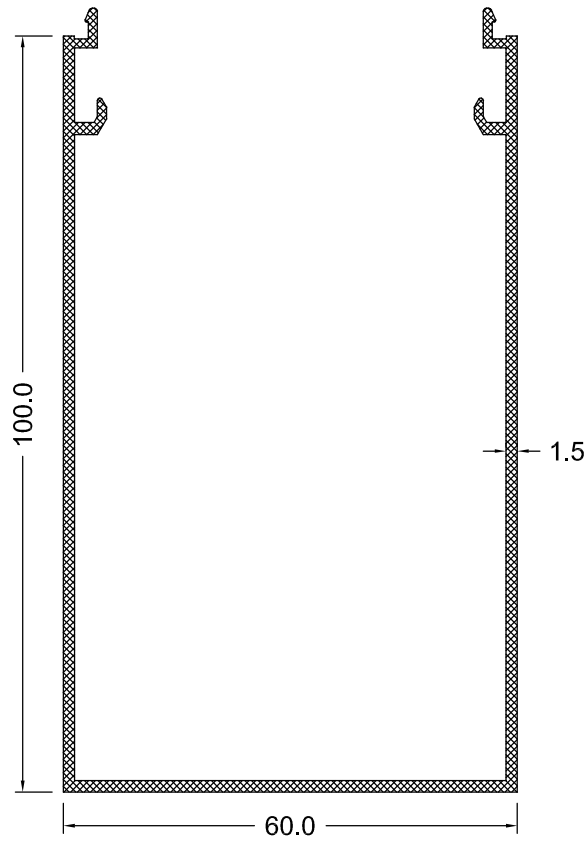



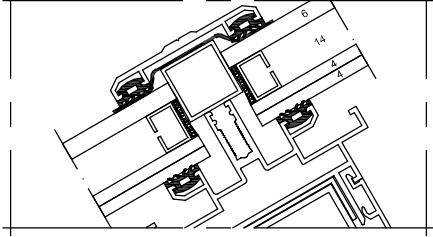

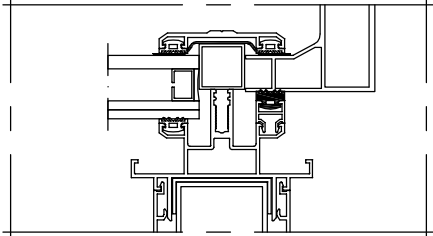

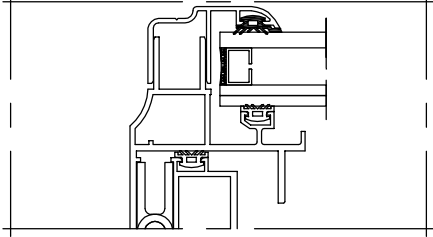
PROFİL KODU	AĞIRLIK (kg/m)
SKY-046	0.810

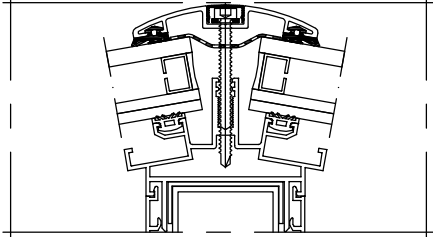
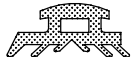
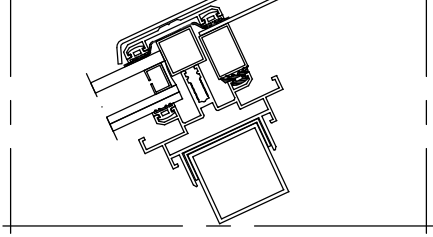
SKY-80

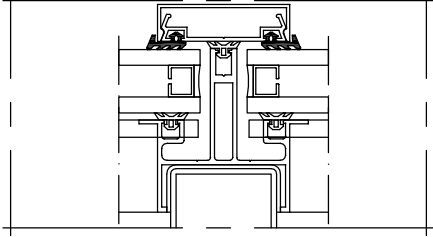

PROFİL KODU	AĞIRLIK (kg/m)
SKY-047	1.133

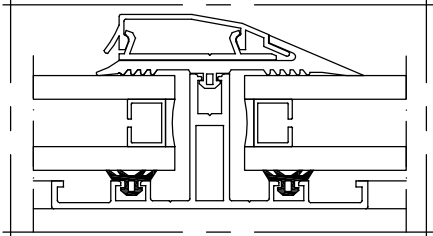
Fitil Kodu	Fitil Resmi	Teslimat Şekli	Montaj Çizimi
<u>EPC 20</u>		1 KOLİ 250mt/15Kg 60gr/m	
<u>EPC 24</u>		1 KOLİ 200mt/15Kg 75gr/m	
<u>EPC 55</u>		1 KOLİ 215mt/15Kg 69gr/m	
<u>EPC 75</u>		1 KOLİ 230mt/15Kg 65gr/m	
<u>EPC 66</u>		1 KOLİ 240mt/15Kg 62gr/m	

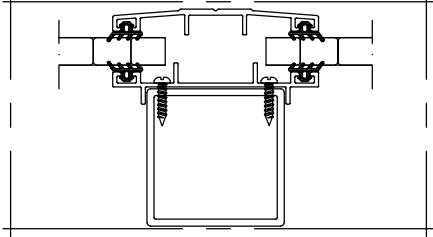
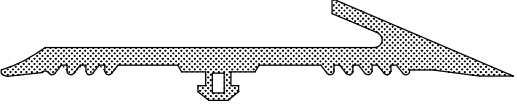
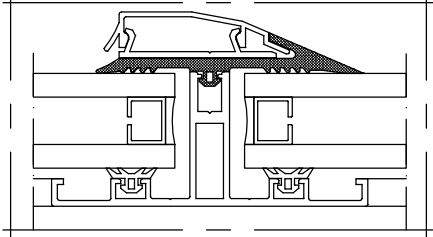
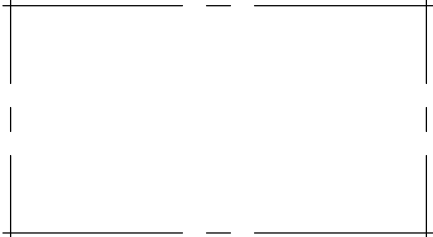
Fıtıl Kodu	Fıtıl Resmi	Teslimat Şekli	Montaj Çizimi
<u>EPC 77</u>		1 KOLİ 185mt/13Kg 70gr/m	
<u>EPC 78</u>		1 KOLİ 375mt/15Kg 40gr/m	
<u>EPC 79</u>		1 KOLİ 500mt/15Kg 30gr/m	
<u>EPC 76</u>		1 KOLİ 50mt 15Kg 300gr/m	
			



ALUFOUR

ÇATI IŞIKLIK SİSTEMİ

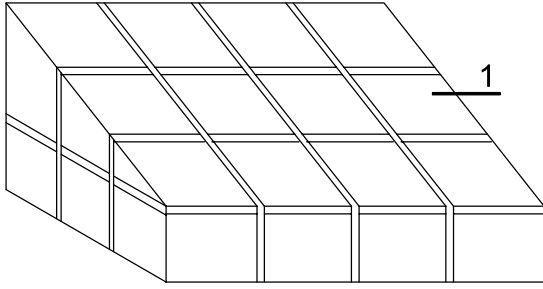

AÇILIR KASET DÜŞEY BİRLEŞİM DETAYI

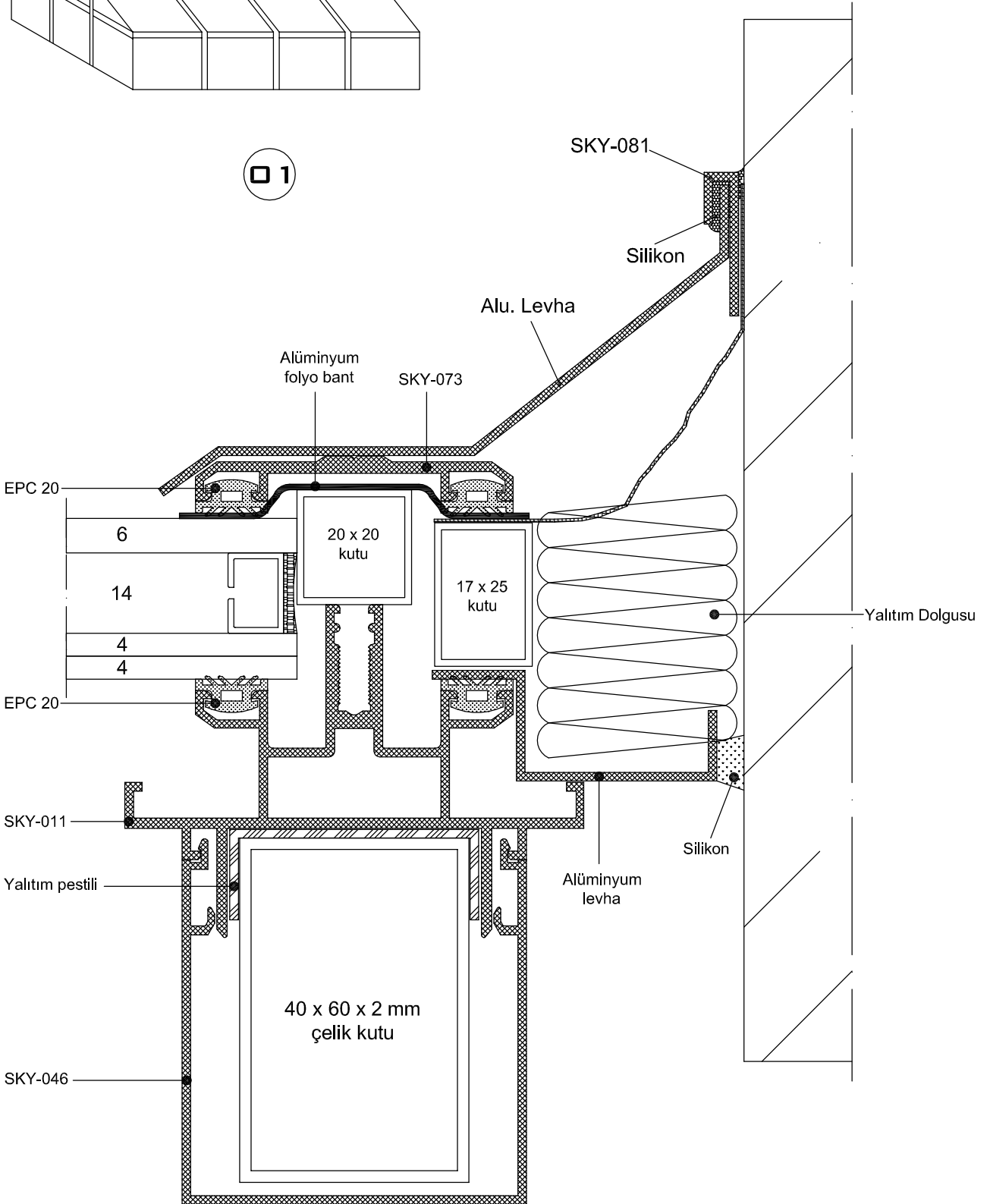

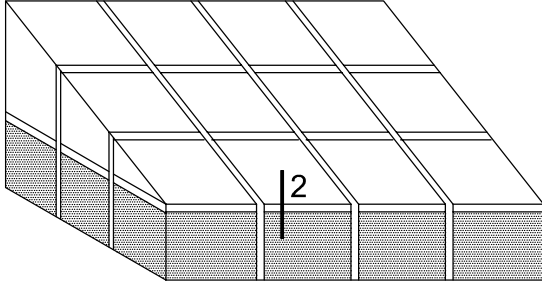

02

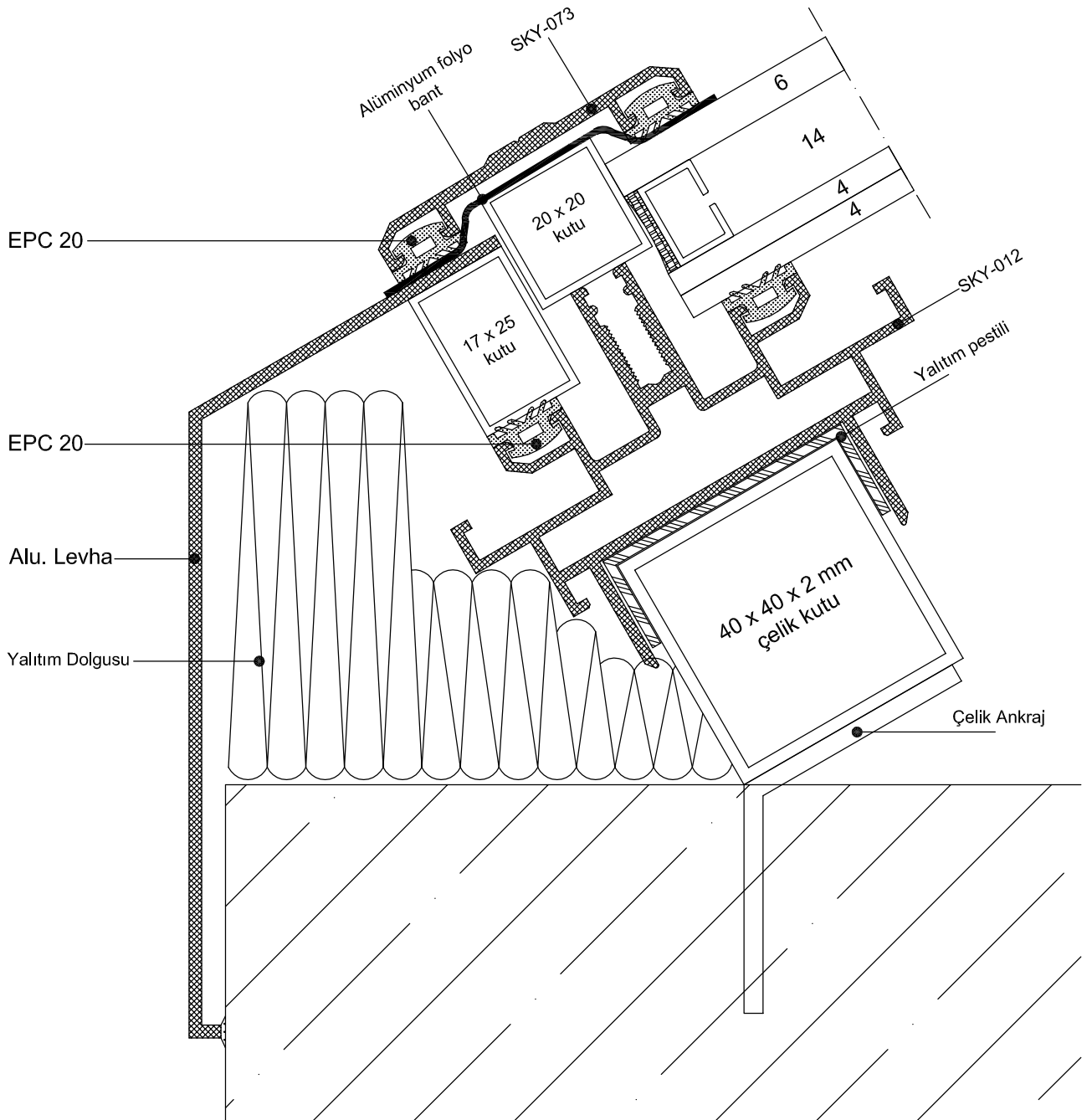

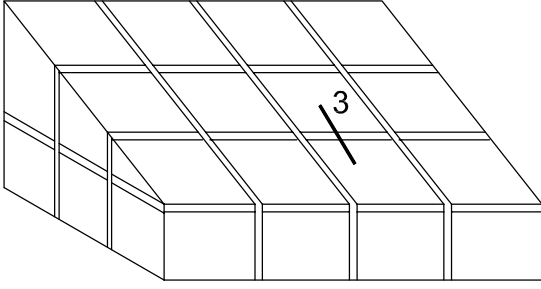

03

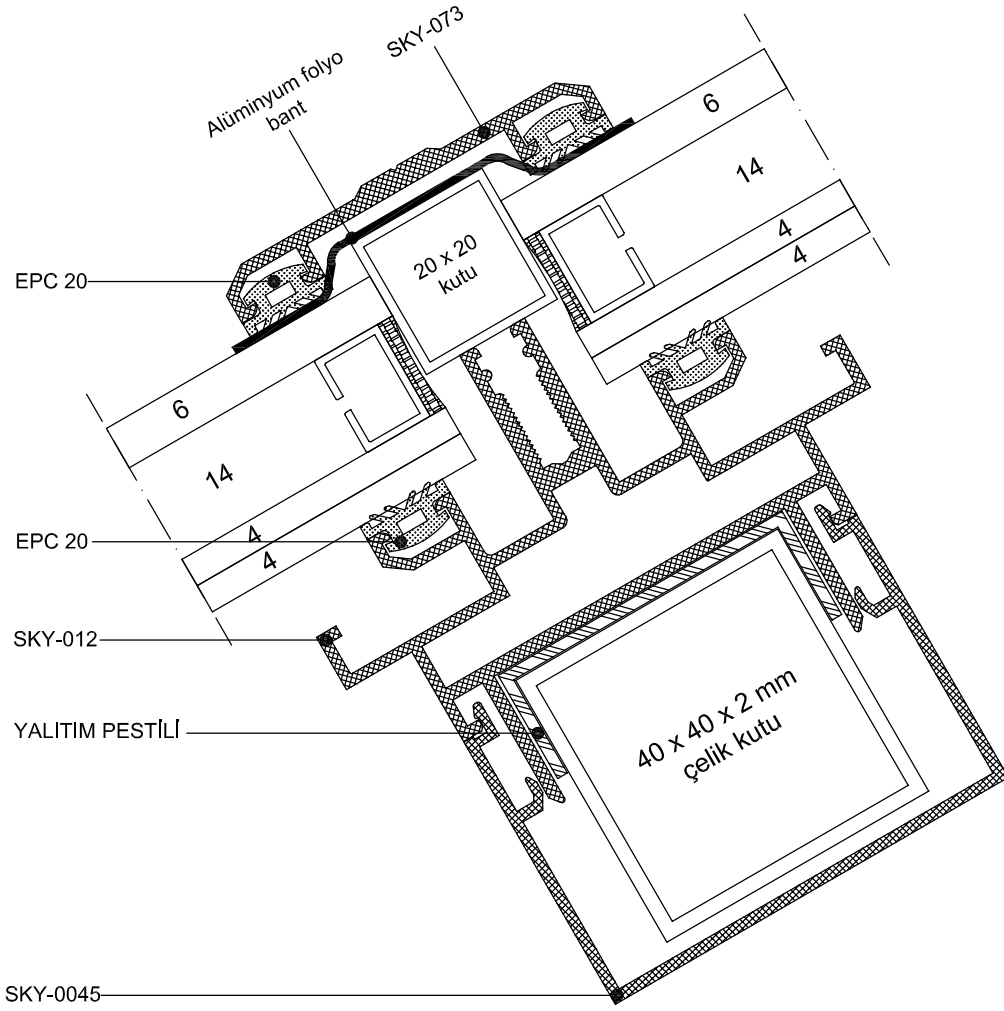

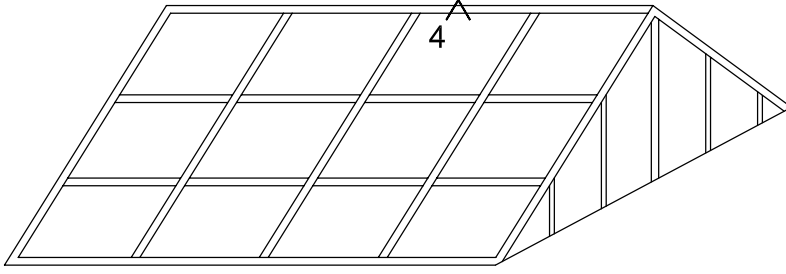

04

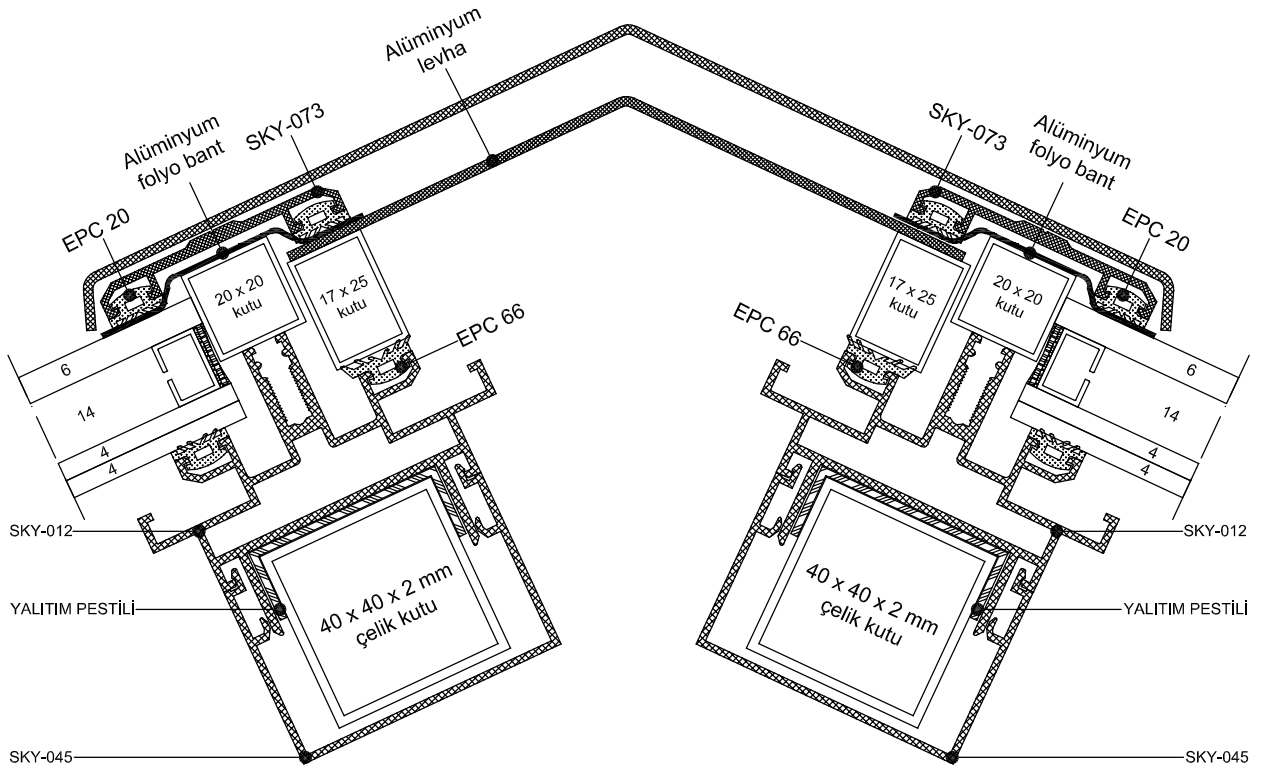

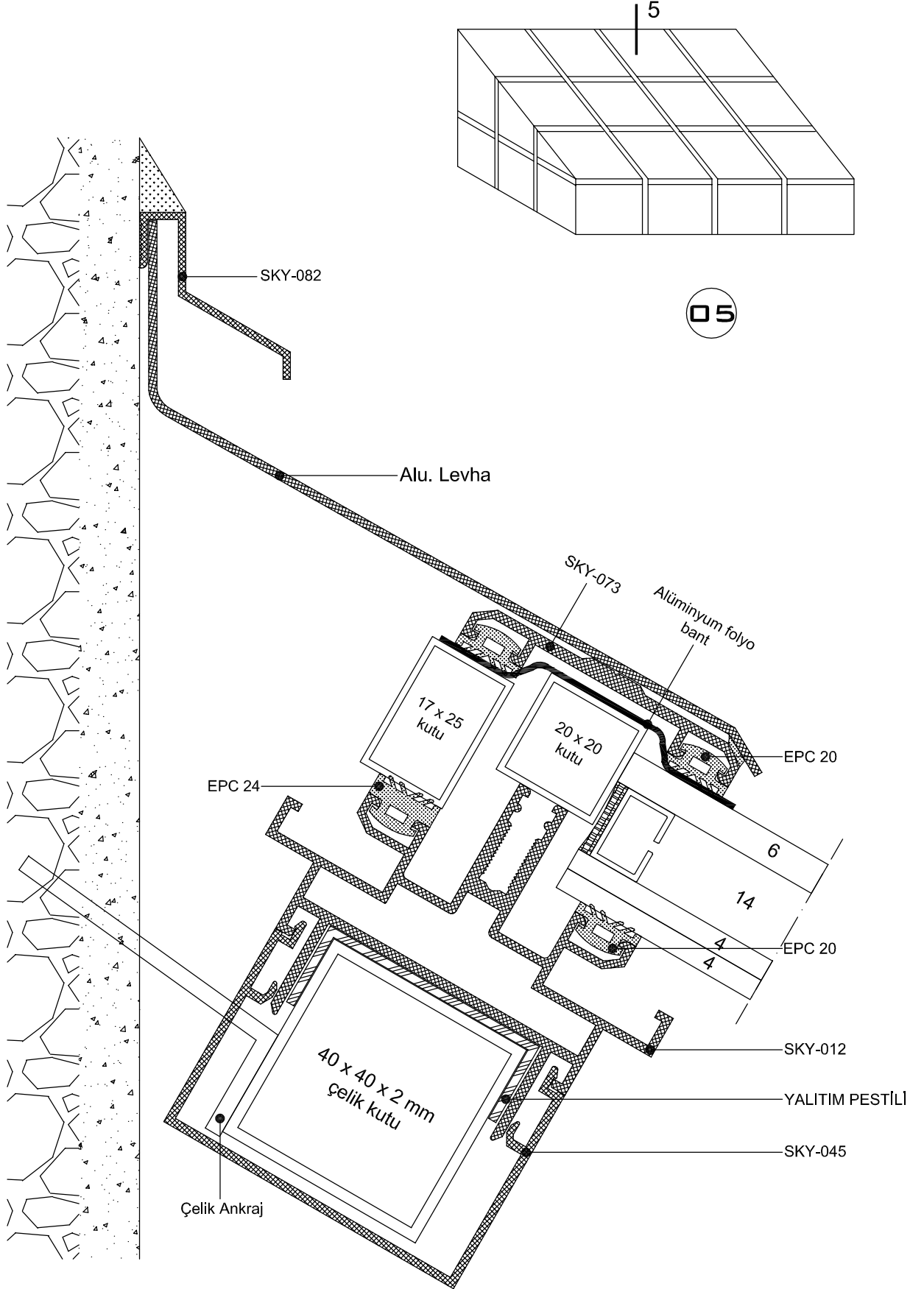

AÇILIR KASET DÜŞEY BİRLEŞİM
DETAYI

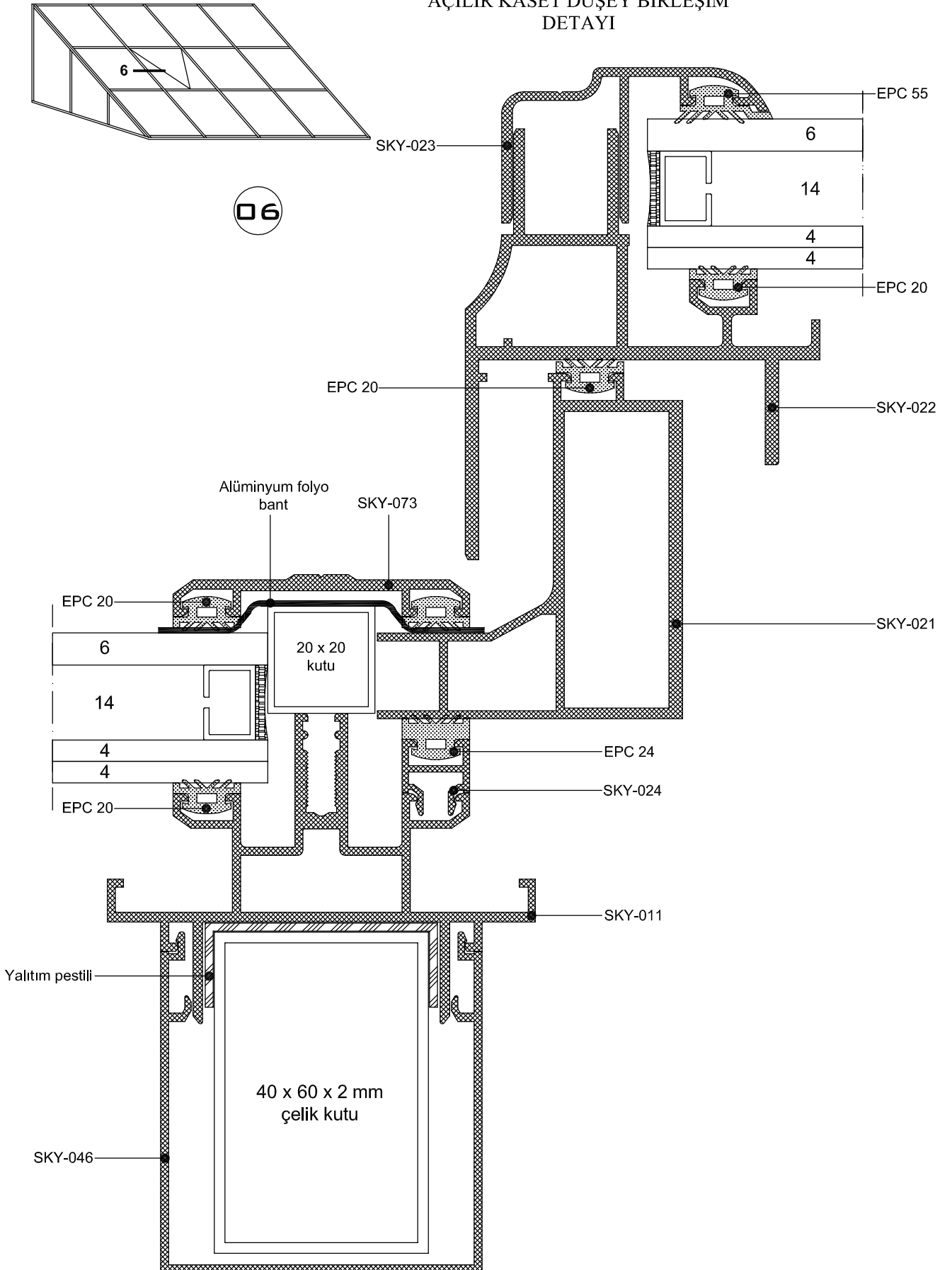

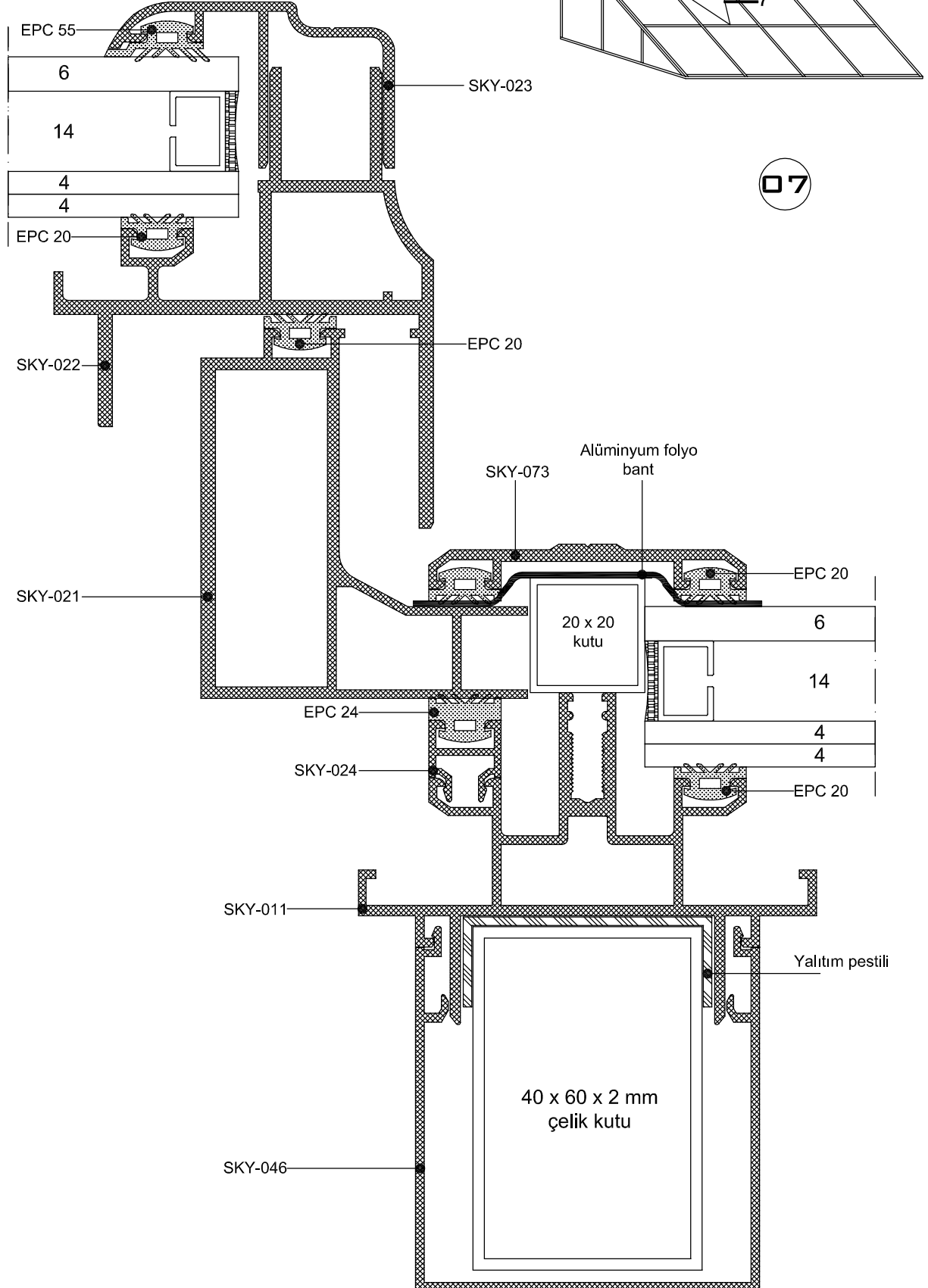
AÇILIR KASET DÜŞEY BİRLEŞİM
DETAYI

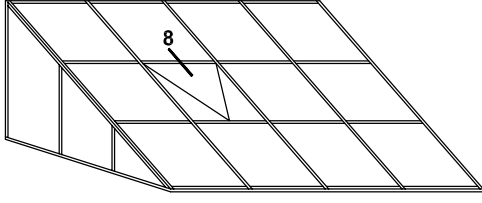

AÇILIR KASET YATAY BİRLEŞİM DETAYI

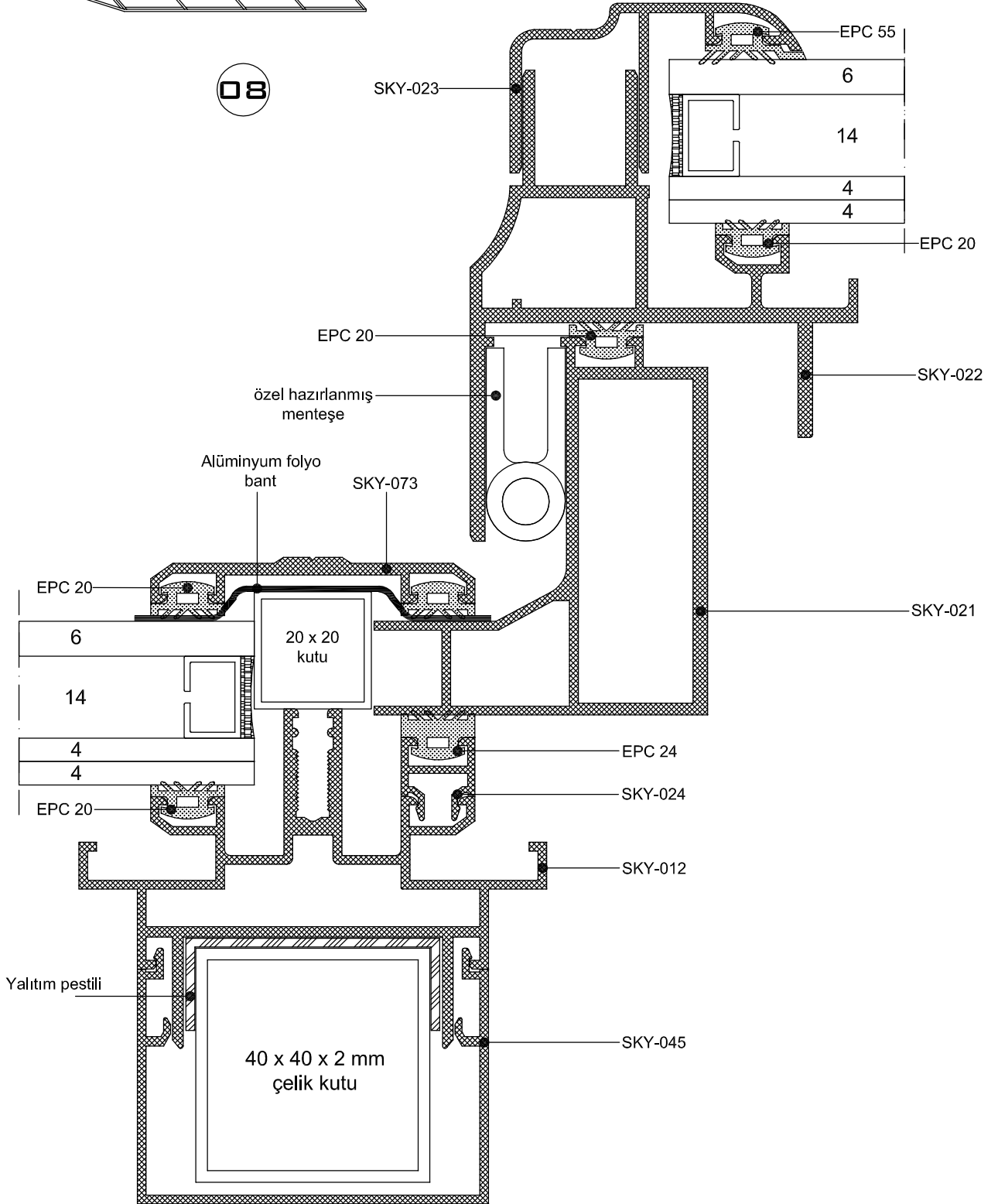

AÇILIR KASET DÜŞEY BİRLEŞİM
DETAYI

09

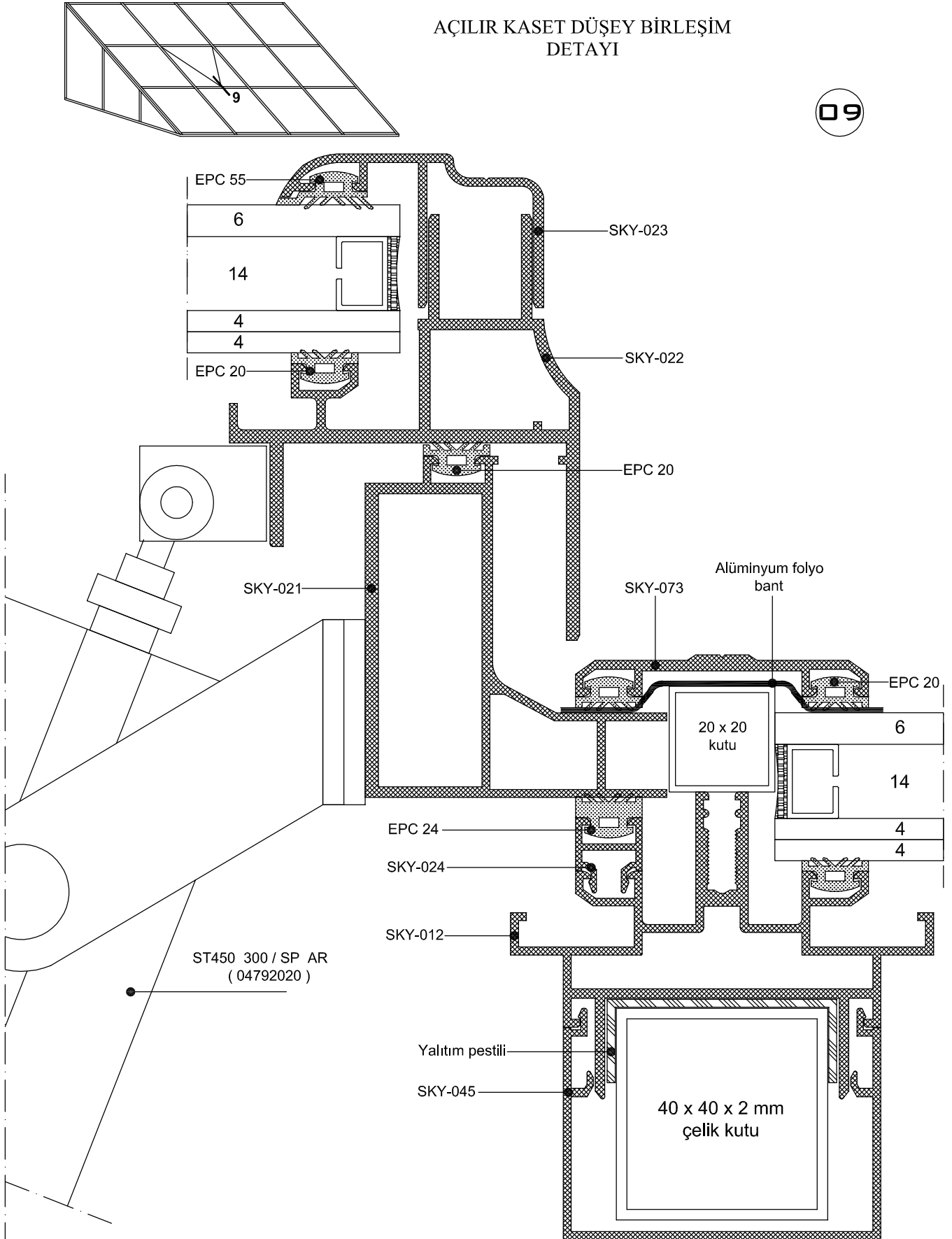

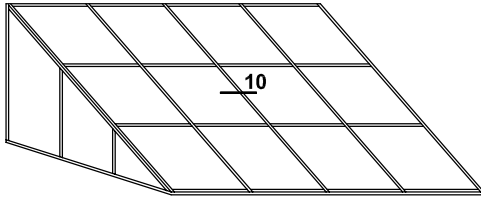

10

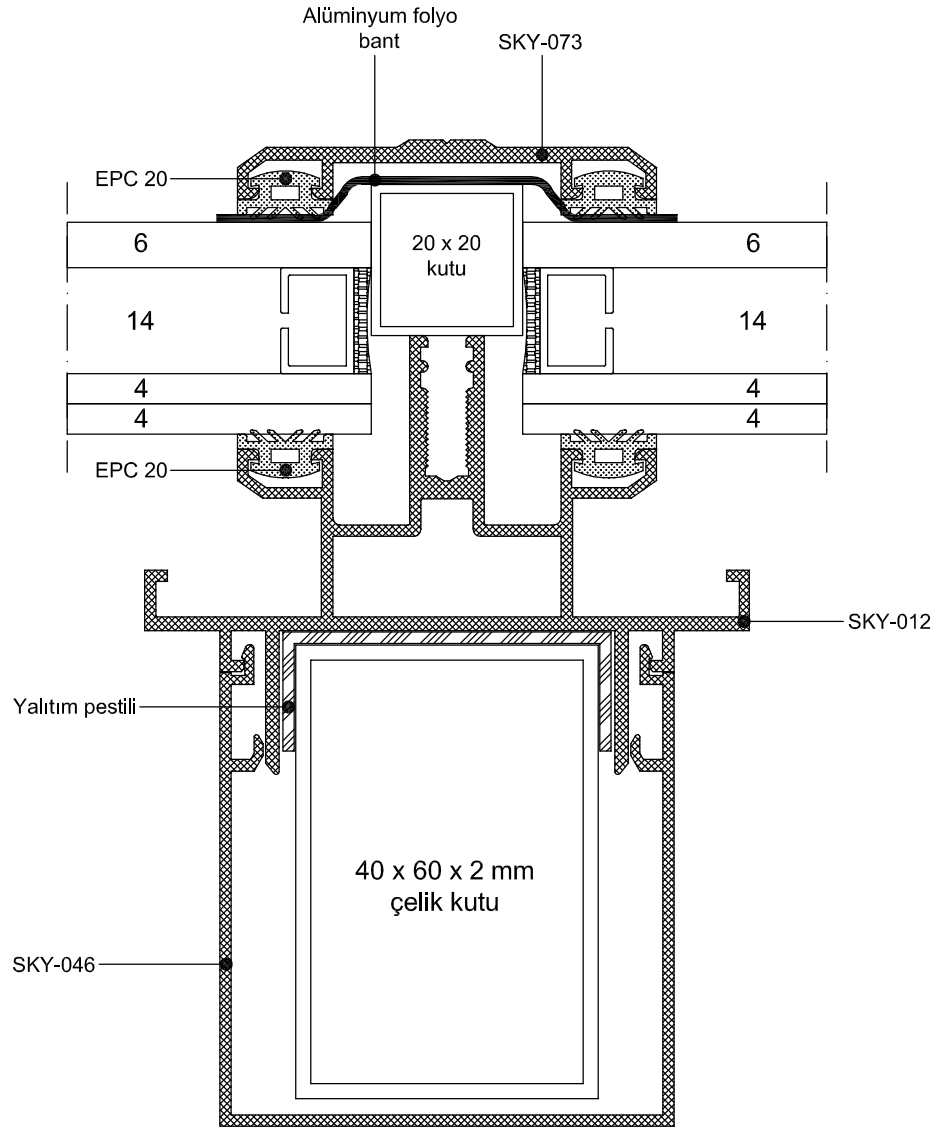

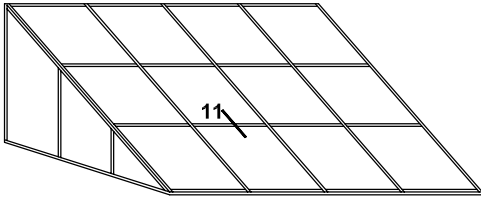

11

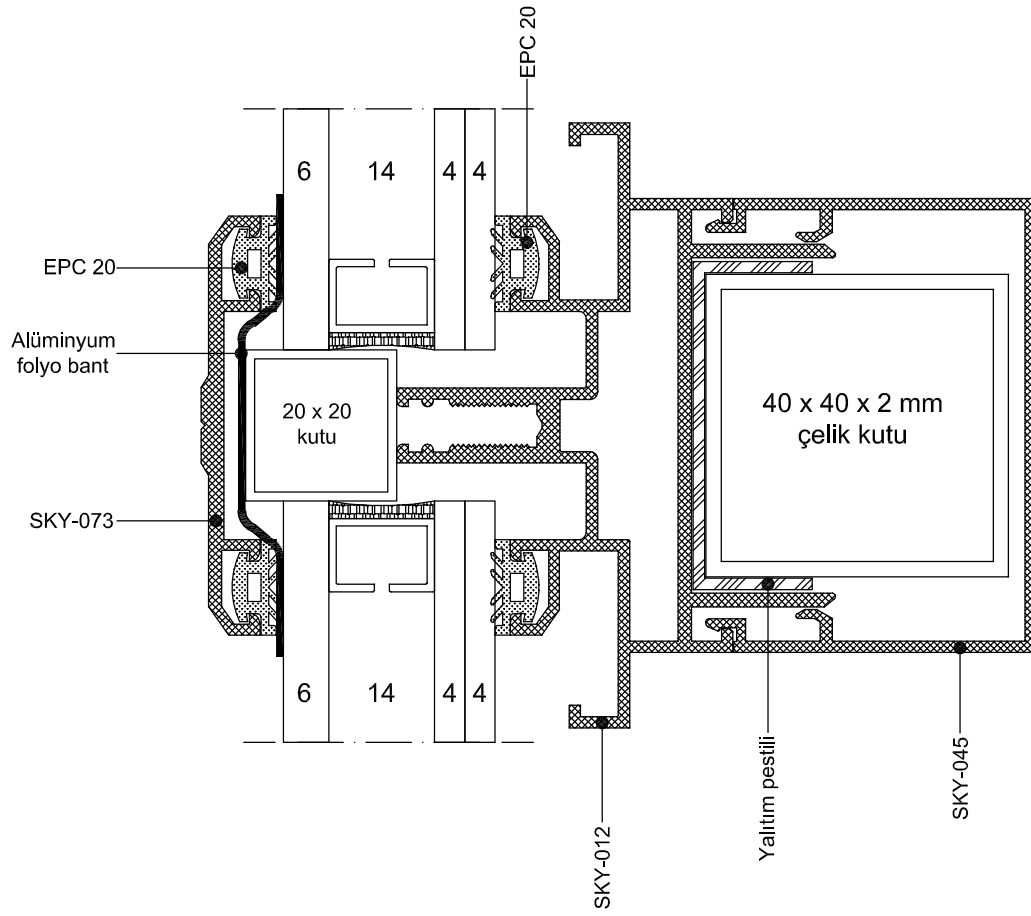

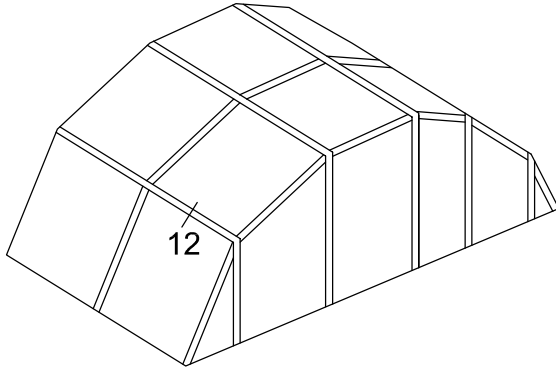

12

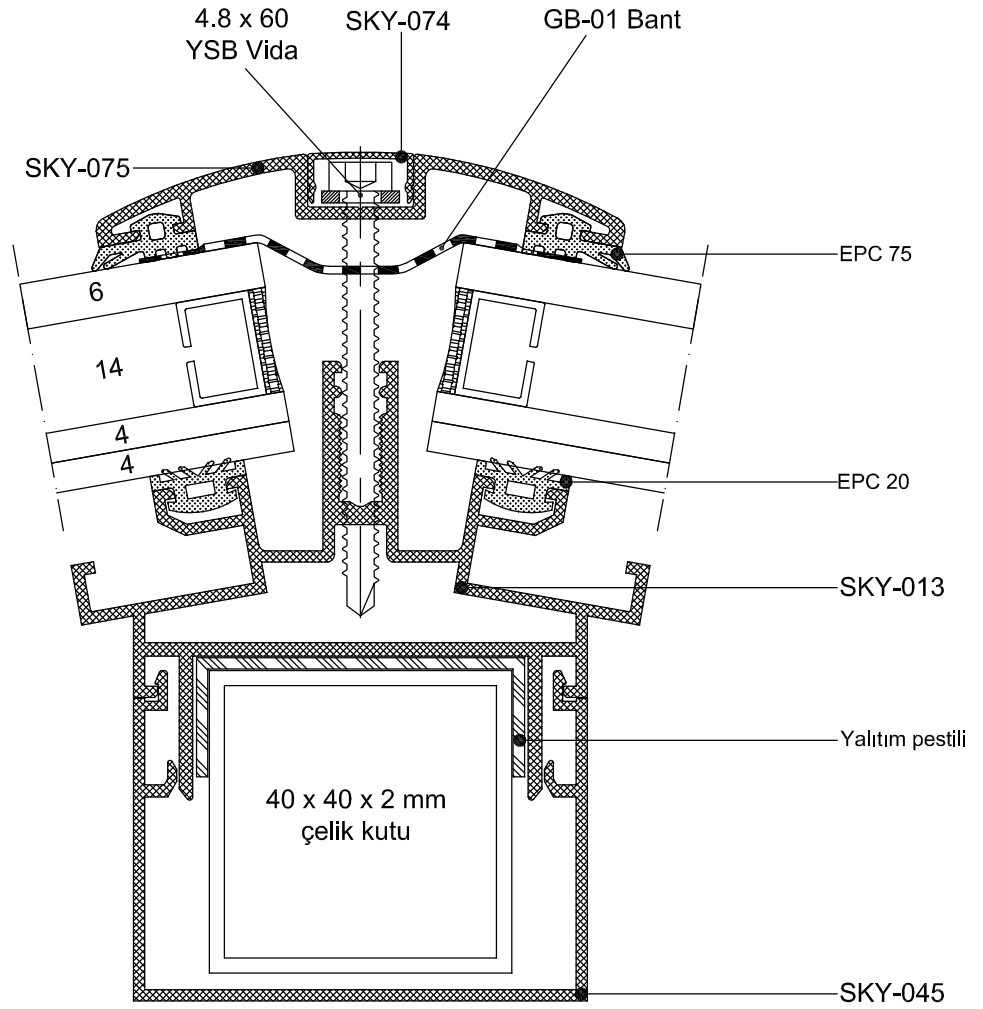

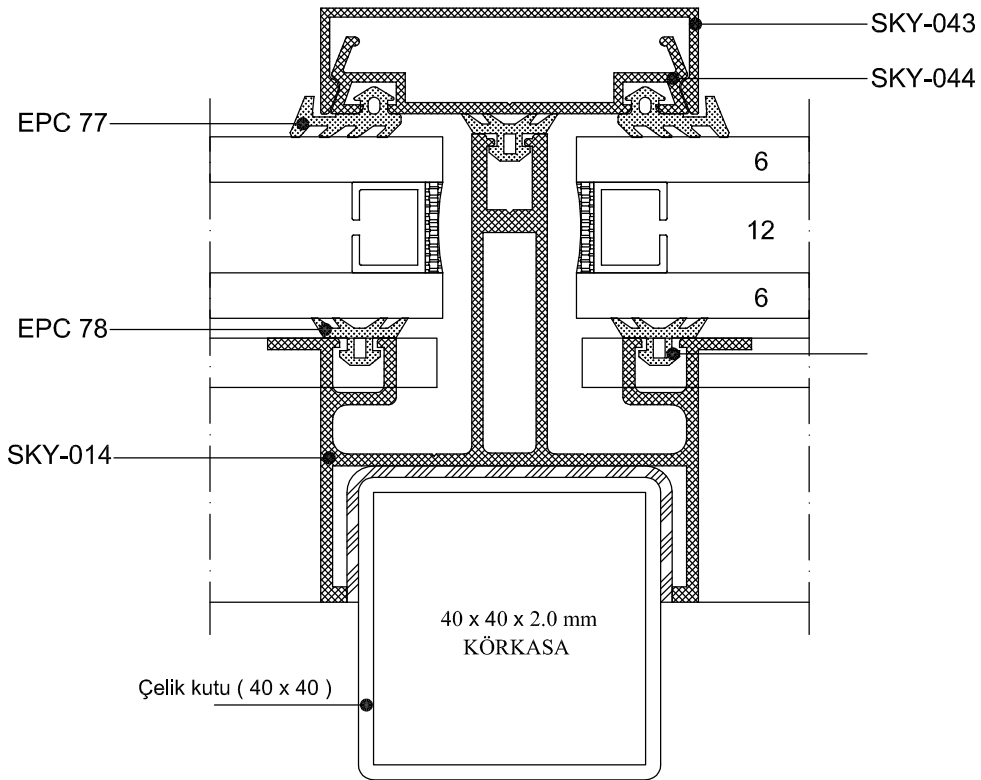

13

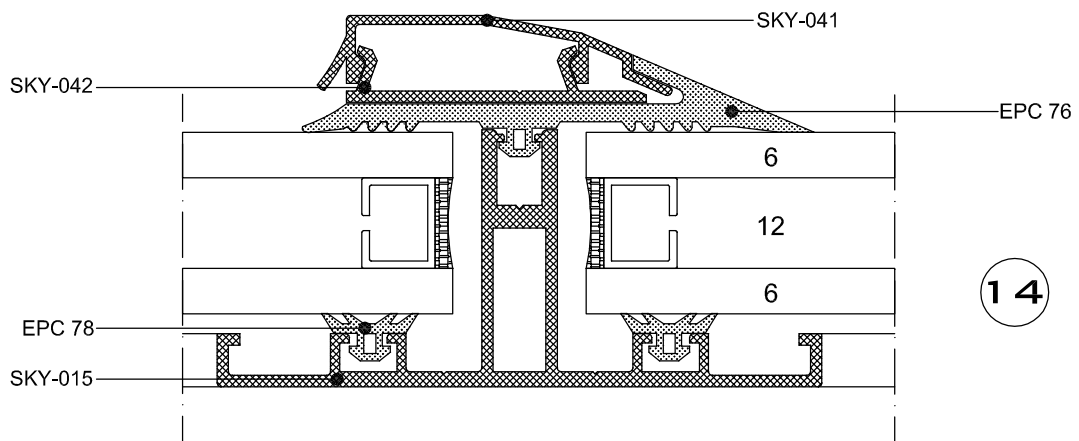

14

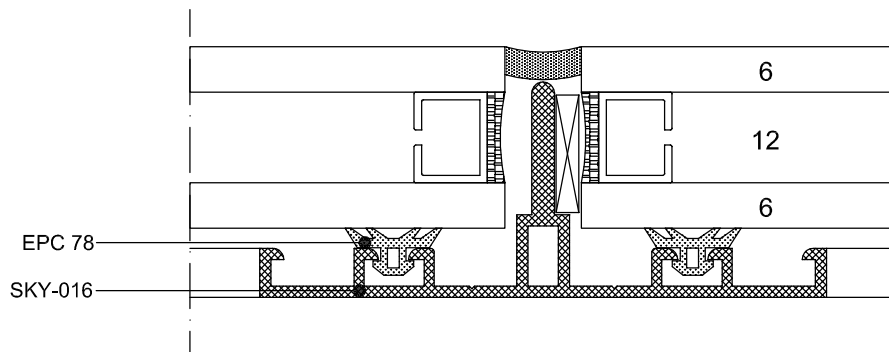

15

POLİKARBON LEVHA UYGULAMA
DETAYI

16

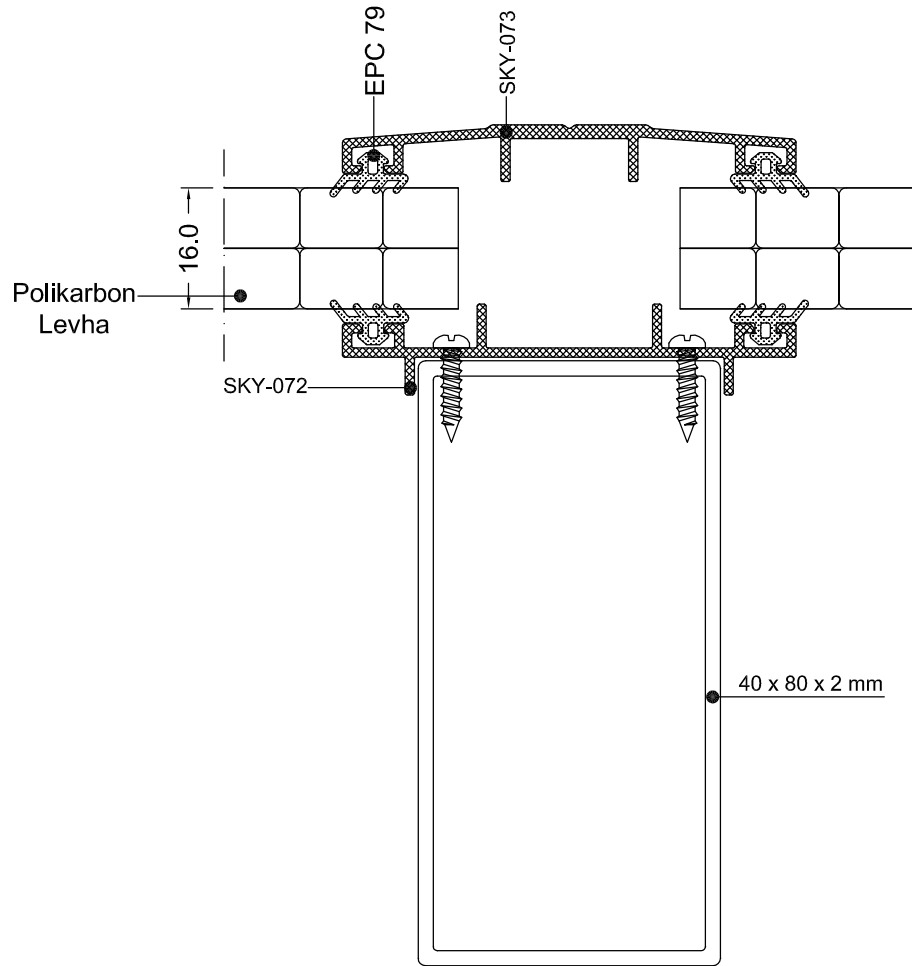

POLİKARBON LEVHA UYGULAMA
DETAYI

17

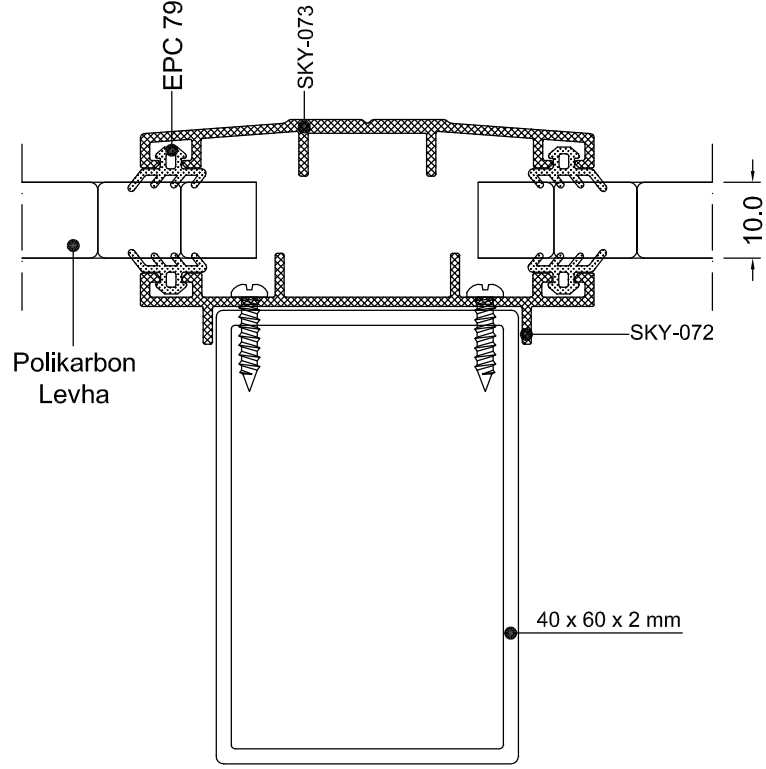

18

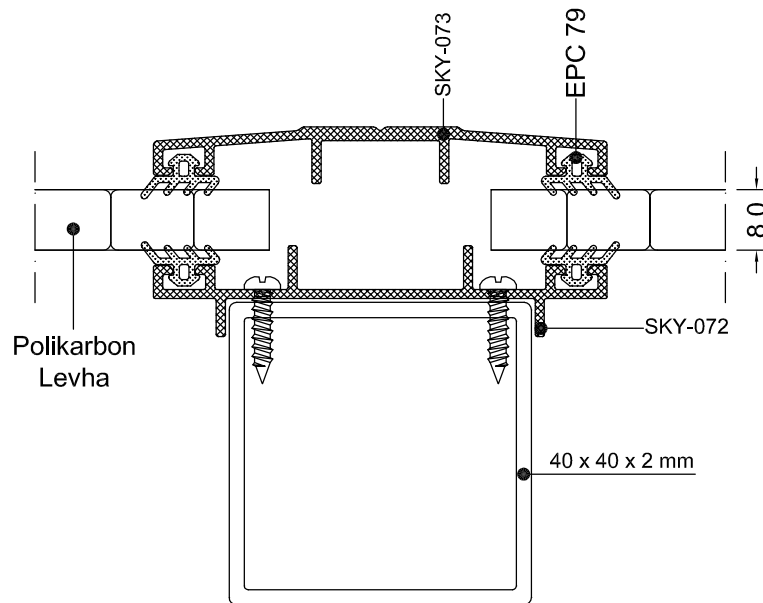



ALUFOUR

ÇATI IŞIKLIK SİSTEMİ